

Ornamental Pole Top & Bases

Pelco's decorative pole top and bases make the traffic signal aesthetically pleasing to the eye. In addition to the standar 4-piece, Pelco also manufactures the bases with an easy access door. Available for various pole diameters and with multiple finish options.



Ornamental Pole Top, Cast Alum, 5-1/4" - 24-1/4" Diameter Pole (36" in Height)

PB-5315	Cap Size	Trim Color	Coating
	<input type="text"/>	<input type="text"/>	<input type="text"/>
	5.25 thru 24.25	T__=Paint	PNC=Process No Color P__=Paint

Note:
Cap Size available in 1" increments.

Ornamental Pole Base, 4-Piece Cast Alum

8" - 12" Diameter Pole (27" Footprint)

PB-5354	Pole Diameter	Trim Color	Coating
	<input type="text"/>	<input type="text"/>	<input type="text"/>
	8.00 thru 12.00	T__=Paint	PNC=Process No Color P__=Paint

12" - 15" Diameter Pole (30" Footprint)

PB-5355	Pole Diameter	Trim Color	Coating
	<input type="text"/>	<input type="text"/>	<input type="text"/>
	12.00 thru 15.00	T__=Paint	PNC=Process No Color P__=Paint

10" - 25" Diameter Pole (40" Footprint)

PB-5381	Pole Diameter	Trim Color	Coating
	<input type="text"/>	<input type="text"/>	<input type="text"/>
	10.00 thru 25.00	T__=Paint	PNC=Process No Color P__=Paint

Note: 1. All assemblies are supplied standard with stainless fasteners.
2. See Reference Section page v for available paint colors.



Ornamental Pole Top & Bases

Pelco's decorative pole top and bases make the traffic signal aesthetically pleasing to the eye. In addition to the standard 4-piece, Pelco also manufactures the bases with an easy access door. Available for various pole diameters and with multiple finish options.



Ornamental Pole Base, 4-Piece Cast Alum w/ Access Door

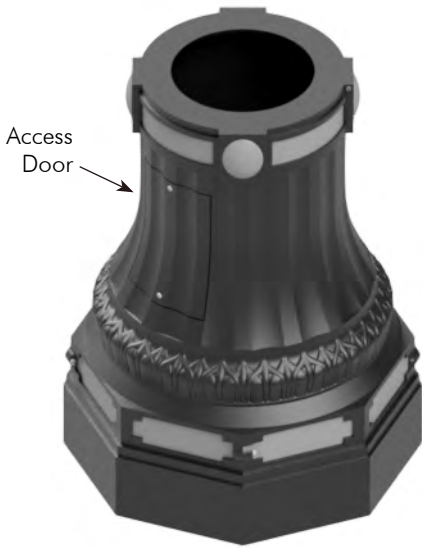

8" - 12" Diameter Pole (27" Footprint)

	Pole Diameter	Trim Color	Coating
PB-5509	- <input type="text"/> - 8.00 thru 12.00	- <input type="text"/> - T__=Paint	- <input type="text"/> - PNC=Process No Color P__=Paint

12" - 15" Diameter Pole (30" Footprint)

	Pole Diameter	Trim Color	Coating
PB-5510	- <input type="text"/> - 12.00 thru 15.00	- <input type="text"/> - T__=Paint	- <input type="text"/> - PNC=Process No Color P__=Paint

10" - 25" Diameter Pole (40" Footprint)

	Pole Diameter	Trim Color	Coating
PB-5519	- <input type="text"/> - 10.00 thru 25.00	- <input type="text"/> - T__=Paint	- <input type="text"/> - PNC=Process No Color P__=Paint

Note: 1. All assemblies are supplied standard with stainless fasteners.
2. See Reference Section page v for available paint colors.



Pole & Arm Clamps

Pelco's strain pole clamps are available in various sizes and configurations from 1-way to 4-way. All clamps are hot dip galvanized per ASTM A123.

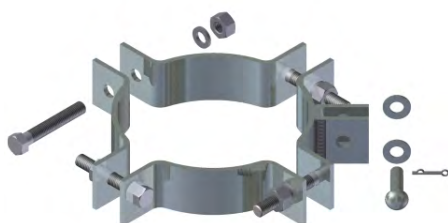

Strain Pole Clamp Assy, 1-Way, Steel

Diameter Range:	5-1/2" to 7-1/2"	7-1/2" to 10-1/2"	10-1/2" to 13-1/2"	13-1/2" to 16-1/2"
Part No.:	AP-1052-GLV	AP-1003-GLV	AP-1051-GLV	AP-1151-GLV



Strain Pole Clamp Assy, 2-Way, Steel

Diameter Range:	5-1/2" to 7-1/2"	7-1/2" to 10-1/2"	10-1/2" to 13-1/2"	13-1/2" to 16-1/2"
Part No.:	AP-1115-GLV	AP-1004-GLV	AP-1113-GLV	AP-1152-GLV

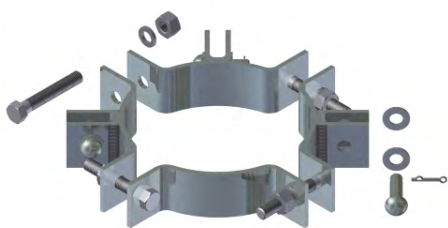

Strain Pole Clamp Assy, 3-Way, Steel

Diameter Range:	5-1/2" to 7-1/2"	7-1/2" to 10-1/2"	10-1/2" to 13-1/2"	13-1/2" to 16-1/2"
Part No.:	-	AP-1005-GLV	-	-

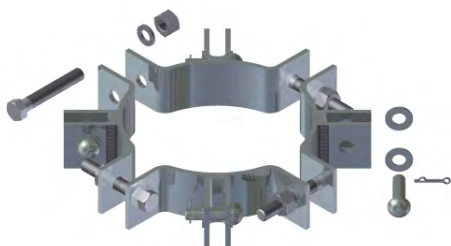

Strain Pole Clamp Assy, 4-Way, Steel

Diameter Range:	5-1/2" to 7-1/2"	7-1/2" to 10-1/2"	10-1/2" to 13-1/2"	13-1/2" to 16-1/2"
Part No.:	AP-1114-GLV	AP-1006-GLV	-	AP-1154-GLV

Note: All assemblies are supplied standard with galvanized fasteners.



Pole & Arm Clamps

Pelco's strain pole clamps are available in various sizes and configurations from 1-way to 4-way. All clamps are hot dip galvanized per ASTM A123.



Strain Pole Clamp Assy, 1-Way 2-Piece w/ Eyelet, Steel

Diameter Range:	7-1/2" to 8-1/4"	8-1/4" to 8-3/4"	9" to 10"	10" to 11"	10-3/4" to 11-3/4"	12" to 13"
Part No.:	AP-1053-GLV	AP-1054-GLV	AP-1055-GLV	AP-1056-GLV	AP-1072-GLV	AP-1057-GLV

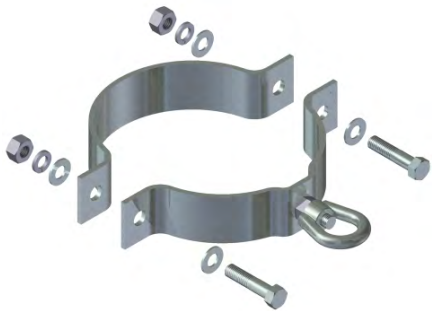

Strain Pole Clamp Assy, 2-Way 2-Piece w/ Eyelet, Steel

Diameter Range:	7-1/2" to 8-1/4"	8-1/4" to 8-3/4"	9" to 10"	10" to 11"	10-3/4" to 11-3/4"	12" to 13"
Part No.:	AP-1122-GLV	AP-1123-GLV	-	-	-	-



Note: All assemblies are supplied standard with galvanized fasteners.



ITC Access Compartments

Pelco's ITC, Integral Terminal Compartment and Hand Hole, is an industry standard that has a low profile and unobstructed opening. The fold-out terminal plate provides for easier wiring access. Available with three terminal block options.



MAST ARMS & POLES

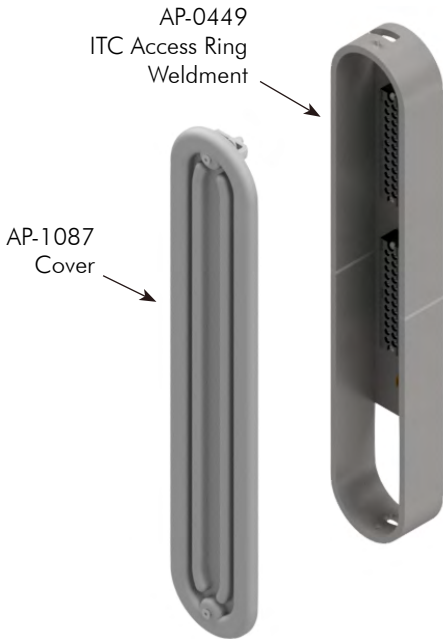

ITC Access Compartment w/ Door 3/8" x 4-3/4" x 27" w/ 12 Circuit

AP-1083	-	Terminal Block	-	Double Fuse Block	-	Coating
		<input type="checkbox"/>		<input type="checkbox"/>		<input type="checkbox"/>
		85A=Compression 65A=Compression 30A=Barrier Strip		Blank=None 3AF=3 Amp Fuse 10F=10 Amp Fuse		PNC=Process No Color P__=Paint

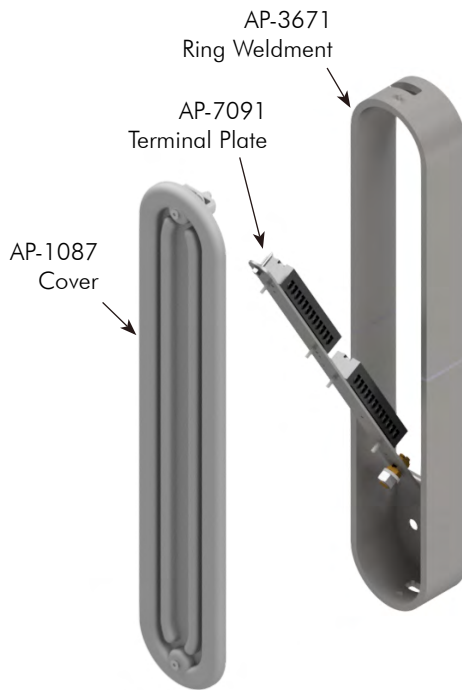
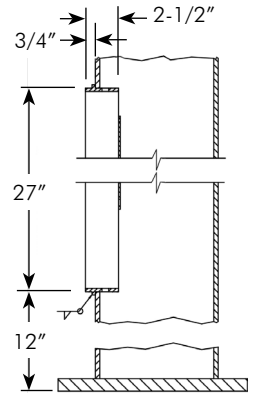

ITC Access Compartment w/ Door Fold out Terminals 3/8" x 4-3/4" x 27" w/ 12 Circuit

AP-1125	-	Terminal Block	-	Double Fuse Block	-	Coating
		<input type="checkbox"/>		<input type="checkbox"/>		<input type="checkbox"/>
		85A=Compression 65A=Compression 30A=Barrier Strip		Blank=None 3AF=3 Amp Fuse 10F=10 Amp Fuse		PNC=Process No Color P__=Paint

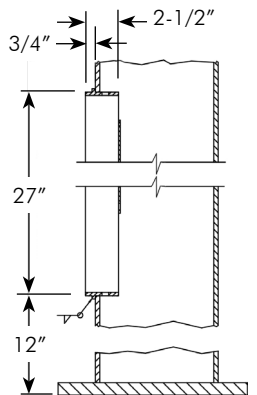

Note: 1. All assemblies are supplied standard with stainless steel fasteners.
2. See Reference Section page v for available paint colors.



ITC Access Compartments

Pelco's ITC, Integral Terminal Compartment and Hand Hole, is an industry standard that has a low profile and unobstructed opening. The fold-out terminal plate provides for easier wiring access. Available with three terminal block options.



AP-1087-PNC **ITC Cover Assembly,
Vacuum formed ABS**



AP-1081-PNC **Double Fuse Block Kit, 600V, 3 Amp Fuse**



AP-1117-PNC **Double Fuse Block Kit, 600V, 10 Amp Fuse,
Texas Spec**

Note: All assemblies are supplied standard with stainless steel fasteners.



ITC Access Compartments

Pelco's ITC, Integral Terminal Compartment and Hand Hole, is an industry standard that has a low profile and unobstructed opening. The fold-out terminal plate provides for easier wiring access. Available with three terminal block options.

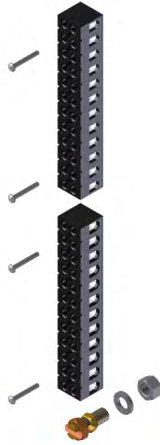

AP-1082-PNC **Terminal Block Assy, 85 Amp, 600V Compression Terminal Block w/ Hardware and Copper Ground Connector**

Note:
Terminal block conductor range for 85 Amp compression block option is 1-#18 thru 4-#10 per screw.



AP-1065-PNC **Terminal Block Assy, 65 Amp, 600V Compression Terminal Block w/ Hardware and Copper Ground Connector**

Note:
Terminal block conductor range for 65 Amp compression block option is 1-#18 thru 3-#12 per screw.



AP-1074-PNC **Terminal Block Assy, 30 Amp, 300V Terminal Strip Barrier Type w/ Hardware and Copper Ground Connector**

Note: All assemblies are supplied standard with stainless steel fasteners.



This page is intentionally left blank.



Foundation Anchors

Pelco's foundation anchors feature a top plate which enables the bolt head to be inserted after the anchor is in place. This eliminates the necessity of digging under the plate to install base bolts. Plate scrapers loosen the soil for easy bolt installation from top of the plate. The bolt is held by the plate scraper which prevents it from turning.



PB-5369-GLV Foundation Anchor Assy, 3" Sch 40 x 4'-0" 4-1/2" to 6-1/2" Bolt Circle, 1/2"-13NC Hardware

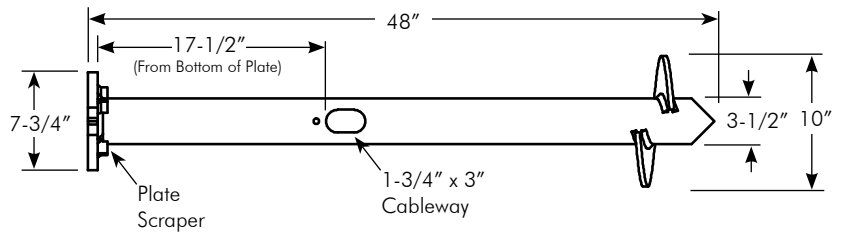

Note:
For residential, ornamental, and walkway lighting with small bases. (wt. 46 lbs.)



PB-5508-GLV Foundation Anchor Assy, 3 1/2" Sch 40 x 4'-0" 4-1/2" to 6-1/2" Bolt Circle, 1/2"-13NC Hardware

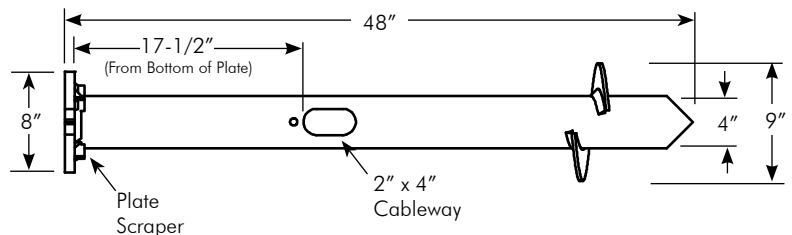

Note:
For residential, ornamental, and walkway lighting with small bases. (wt. 49 lbs.)

- Note: 1. Foundation anchors are hot dip galvanized per ASTM A123.
 2. All assemblies are supplied with Grade 5 Galvanized Bolts.
 3. All assemblies with hardware are bagged in a nylon weatherproof bag.



Foundation Anchors

Pelco's foundation anchors feature a top plate which enables the bolt head to be inserted after the anchor is in place. This eliminates the necessity of digging under the plate to install base bolts. Plate scrapers loosen the soil for easy bolt installation from top of the plate. The bolt is held by the plate scraper which prevents it from turning.



MAST ARMS & POLES

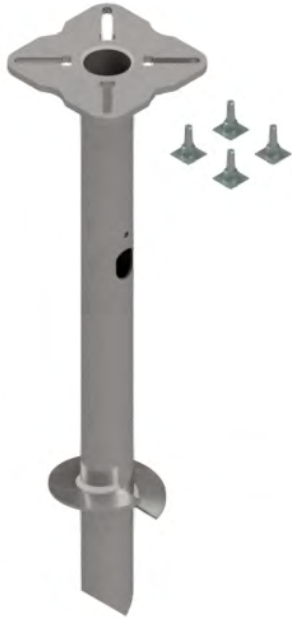

PB-5364-GLV Foundation Anchor Assy, 4" Sch 40 x 4'-8" 8-1/4" to 14-3/4" Bolt Circle 3/4"-10NC Hardware

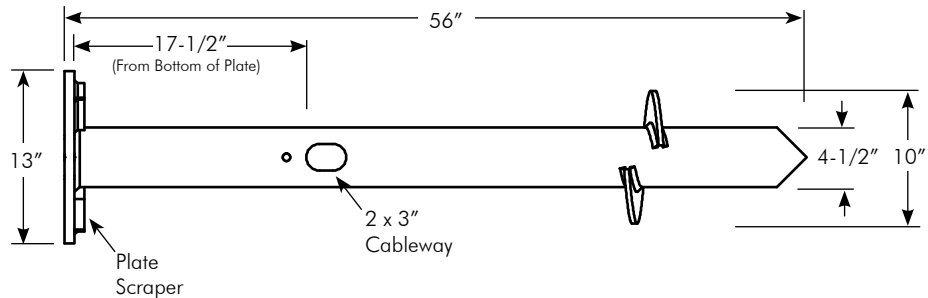

Note:
For residential lights, parking lots, and street lights. Typically for pole heights up to 16'. (wt. 94 lbs.)



Foundation Anchor Assy, 6" Sch 40 x Length 9" to 14" Bolt Circle 5/8"-11NC Hardware

PB-5550 - Length - GLV
84=7'-0"

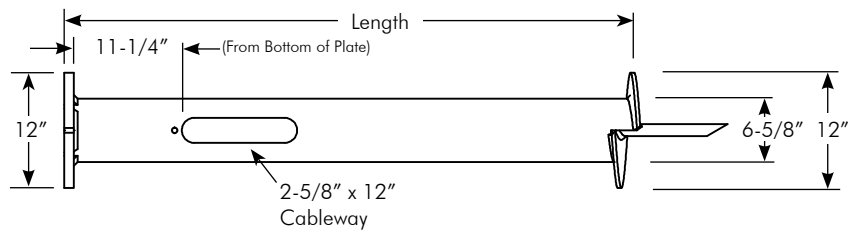

Note:
84" (wt. 172 lbs.)

pelco
PELCO PRODUCTS, INC.

- Note: 1. Foundation anchors are hot dip galvanized per ASTM A123.
- 2. All assemblies are supplied with Grade 5 Galvanized Bolts.
- 3. All assemblies with hardware are bagged in a nylon weatherproof bag.



Foundation Anchors

Pelco's foundation anchors feature a top plate which enables the bolt head to be inserted after the anchor is in place. This eliminates the necessity of digging under the plate to install base bolts. Plate scrapers loosen the soil for easy bolt installation from top of the plate. The bolt is held by the plate scraper which prevents it from turning.



Foundation Anchor Assy, 6" Sch 40 x Length 9" to 14" Bolt Circle 1"-8NC Hardware

PB-5537 - Length - GLV
 48=4'-0"
 60=5'-0"
 72=6'-0"
 84=7'-0"

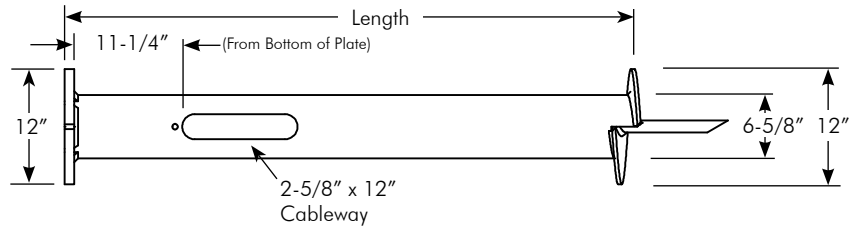

Note:
 48' (wt. 115 lbs.); 60" (wt. 134 lbs.); 72" (wt. 152 lbs.); 84" (wt. 172 lbs.)

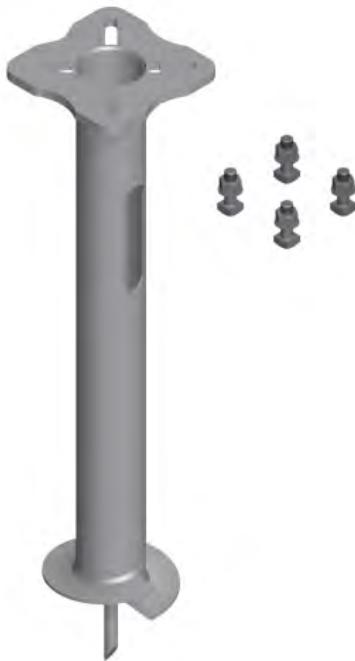

PB-5372-GLV Foundation Anchor Assy, 6" Sch 40 x 5'-0" 10" to 15" Bolt Circle 1"-8NC Hardware

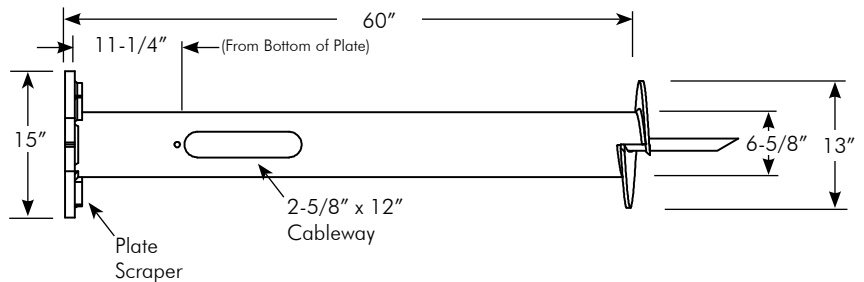

Note:
 For residential lights, parking lots, etc. Typically for poles ranging from 20'-30' in height. (wt. 167 lbs.)

- Note: 1. Foundation anchors are hot dip galvanized per ASTM A123.
 2. All assemblies are supplied with Grade 5 Galvanized Bolts.
 3. All assemblies with hardware are bagged in a nylon weatherproof bag.



Foundation Anchors

Pelco's foundation anchors feature a top plate which enables the bolt head to be inserted after the anchor is in place. The carriage bolts, in the hardware kit, are locked in place by the slots in the top plate, preventing them from turning.

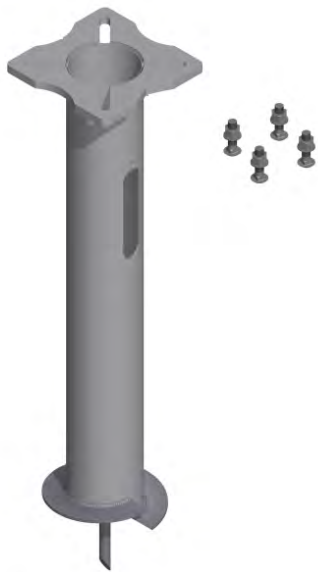

PB-5534-GLV Foundation Anchor Assy, 8" Sch 20 x 5'-0"
11" to 17" Bolt Circle
1"-8NC Hardware

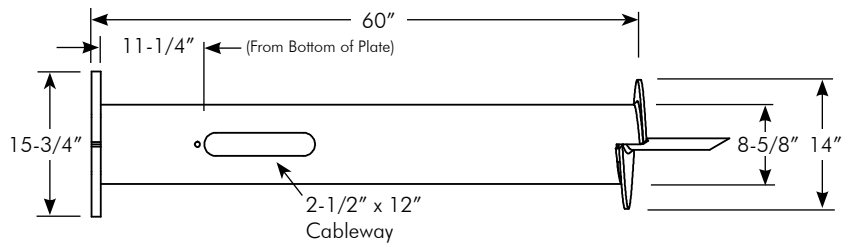

Note:
 For street and highway lighting. Typically for poles ranging from 30'-50' in height. (wt. 184 lbs.)



PB-5375-GLV Foundation Anchor Assy, 8" Sch 40 x 5'-0"
13" to 18" Bolt Circle
1-1/4"-7NC Hardware

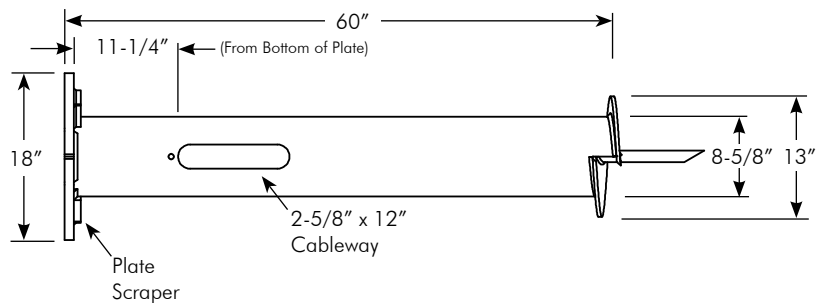

Note:
 For street and highway lighting. Typically for poles ranging from 30'-50' in height. (wt. 239 lbs.)

- Note:
1. Foundation anchors are hot dip galvanized per ASTM A123.
 2. All assemblies are supplied with Grade 5 Galvanized Bolts.
 3. All assemblies with hardware are bagged in a nylon weatherproof bag.



Foundation Anchors

Pelco's foundation anchors feature a top plate which enables the bolt head to be inserted after the anchor is in place. The carriage bolts, in the hardware kit, are locked in place by the slots in the top plate, preventing them from turning.



MAST ARMS & POLES



Foundation Anchor Assy, 10" Sch 20 x 10'-0" 13-1/2" to 17" Bolt Circle 1"-8NC Hardware

PB-5535 - Cableway - GLV
Blank=@ 18"
60=@ 60"

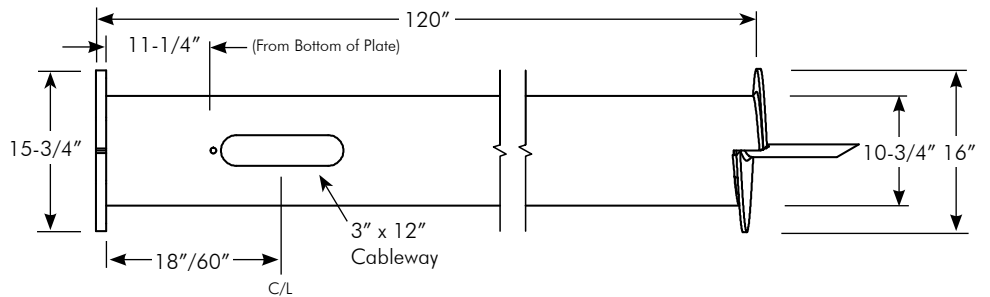

Note:
For street and highway lighting. Typically for poles ranging from 30'-50' in height. (wt. 359 lbs.)

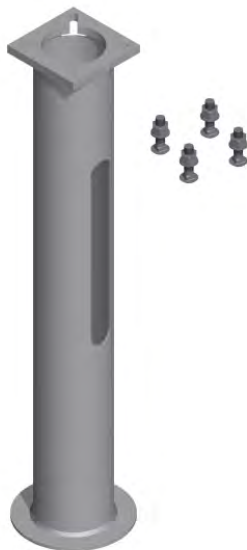

SP-6360-GLV Foundation Anchor Assy, 8" Sch 20 x 5'-0" 8" to 11" Bolt Circle, 3/4"-10NC Hardware

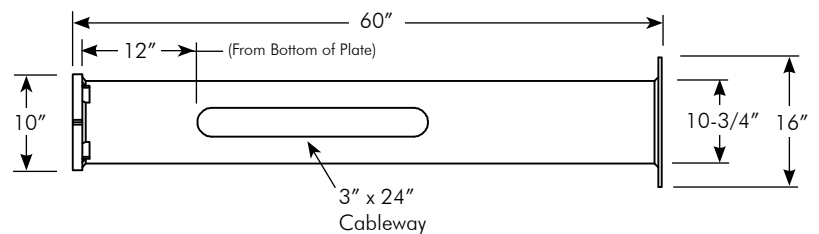

Note:
Designed to be stabilized in concrete footing. Typically for poles up to 30' in height. (wt. 141 lbs)

- Note: 1. Foundation anchors are hot dip galvanized per ASTM A123.
2. All assemblies are supplied with Grade 5 Galvanized Bolts.
3. All assemblies with hardware are bagged in a nylon weatherproof bag.



Foundation Anchors

Various accessories are available to assist in installation of foundation anchors and anchor bolts.



Driver Adapter for Foundation Anchor Steel

PB-0604-ZN1

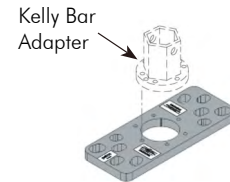

Note: Required to connect the Kelly Bar adapter (not supplied) to the foundation anchor for installation. Special slotted hole patterns permits installation of foundation anchors having bolt circle diameters of 9" to 14-3/4". Zinc 1 Finish.

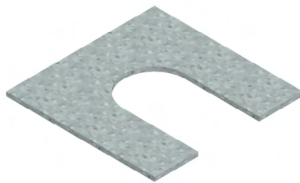

PB-0602-GLV **Shim, 1/16" x 2" x 2" Galvanized Steel**

PB-0603-GLV **Shim, 1/8" x 2" x 2" Galvanized Steel**

AP-3085-PNC **Anchor Bolt Template, ABS Plastic**



- Quick, easy set-up in minutes
- Bolt circle patterns of 7-1/2" to 24-1/2"
- Easy guide divots every 1/2"
- Reusable

The Bolt Template is a reusable "tool" used for layout of bolts to be used in concrete for the future installation of poles. Constructed of UV stabilized ABS plastic, the Bolt Template may be used for various bolt patterns from 7-1/2" up to 24-1/2". Accepts multiple conduits through the center with the capacity for up to two 2" conduits and multiple smaller conduits at one time.

Note: See Section T11 for anchor bolt sets and cages.