

Pedestal Poles

Pelco offers aluminum, iron, and plastic bases in various sizes as well as poles in aluminum and steel. Pelco's cast aluminum square base is FHWA certified and meets or exceeds AASHTO break-away requirements. Plastic replacement doors offer an economical way to deter vandalism.



1



1. Pedestal Pole, 4" Sch 40, Spun Alum No Threads

PB-5101 - Length - Coating

PNC=Process No Color
P__=Paint

2



2. Pedestal Pole, 4"- 8 NPT Sch 40, Spun Alum w/ Pelican ID

PB-5100 - Length - Coating

PNC=Process No Color
P__=Paint

Pedestal Pole, 4"- 8 NPT Sch 80, Spun Alum

PB-5102 - Length - Coating

PNC=Process No Color
P__=Paint

Pedestal Pole, 4"- 8 NPT Sch 40, Steel

PB-5201 - Length - Coating

P__=Paint

Pedestal Pole, 4"- 8 NPT Sch 40, Galv Steel

PB-5200 - Length - GLV - Coating

Blank=Galvanized Only
P__=Paint over Galvanized

3



3. Pedestal Pole, Welded, 4"- 8 NPT w/ 5-1/2" Nipple Length, Steel

PB-5219 - Length - Coating

GLV=Galvanized
P__=Paint

Note: 1. Standard poles are typically sold in 1 foot increments. For other lengths contact sales.
2. See Reference Section for available paint colors.



Square Pedestal Bases Aluminum

Pelco offers aluminum, iron, and plastic bases in various sizes as well as poles in aluminum and steel. Pelco's PB-5334 and PB-5335 cast aluminum square bases are FHWA certified and meets or exceeds AASHTO break-away requirements. Plastic replacement doors offer an economical way to deter vandalism.



Square Base Assembly, Alum w/ Alum Door



| | | | | | | | | |
|---------|---|--------------------------------|---|--|---|-----------------------------|---|-----------------------------------|
| PB-5334 | - | <input type="checkbox"/> | - | <input type="checkbox"/> | - | <input type="checkbox"/> | - | <input type="checkbox"/> |
| | | Door | | Set Screws in Collar | | Grounding Lug | | Coating |
| | | NL=No Logo Blank=Pelco Logo | | 1S=1 Hex Bolt 3S=3 Set Screws Blank=None | | GL=Ground Lug Blank=None | | PNC=Process No Color P__=Paint |

Square Base Assembly, Alum w/ Plastic Door

| | | | | | | | | |
|---------|---|--------------------------------|---|--|---|-----------------------------|---|-----|
| PB-5335 | - | <input type="checkbox"/> | - | <input type="checkbox"/> | - | <input type="checkbox"/> | - | PNC |
| | | Door | | Set Screws in Collar | | Grounding Lug | | |
| | | NL=No Logo Blank=Pelco Logo | | 1S=1 Hex Bolt 3S=3 Set Screws Blank=None | | GL=Ground Lug Blank=None | | |

Square Base Assembly, Alum Heat Treated w/ Alum Door



| | | | | | | | | |
|---------|---|--------------------------------|---|--|---|-----------------------------|---|-----------------------------------|
| PB-5336 | - | <input type="checkbox"/> | - | <input type="checkbox"/> | - | <input type="checkbox"/> | - | <input type="checkbox"/> |
| | | Door | | Set Screws in Collar | | Grounding Lug | | Coating |
| | | NL=No Logo Blank=Pelco Logo | | 1S=1 Hex Bolt 3S=3 Set Screws Blank=None | | GL=Ground Lug Blank=None | | PNC=Process No Color P__=Paint |

Square Base Assembly, Alum Heat Treated w/ Plastic Door

| | | | | | | | | |
|---------|---|--------------------------------|---|--|---|-----------------------------|---|-----|
| PB-5337 | - | <input type="checkbox"/> | - | <input type="checkbox"/> | - | <input type="checkbox"/> | - | PNC |
| | | Door | | Set Screws in Collar | | Grounding Lug | | |
| | | NL=No Logo Blank=Pelco Logo | | 1S=1 Hex Bolt 3S=3 Set Screws Blank=None | | GL=Ground Lug Blank=None | | |

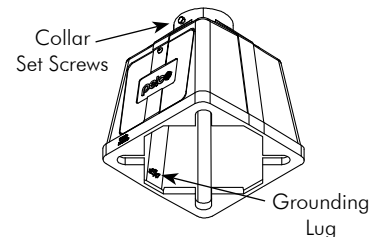
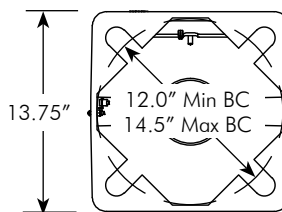
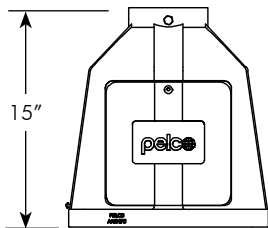

- Note: 1. PB-5334 and PB-5335 aluminum square bases above are available with AASHTO certifications and FHWA approval. Please specify by adding the Certification Part No. C-1001 in addition to the base part number.
2. All assemblies are supplied standard with stainless fasteners.
3. See Reference Section for available paint colors.



Square Pedestal Bases Aluminum

Pelco offers aluminum, iron, and plastic bases in various sizes as well as poles in aluminum and steel. Pelco's PB-5334 and PB-5335 cast aluminum square bases are FHWA certified and meets or exceeds AASHTO break-away requirements. Plastic replacement doors offer an economical way to deter vandalism.



Square Base Assembly, Alum Steel Coupling w/ Alum Door



| | | | | | | | | |
|---------|---|--------------------------------|---|--|---|-----------------------------|---|-----------------------------------|
| PB-5340 | - | <input type="checkbox"/> | - | <input type="checkbox"/> | - | <input type="checkbox"/> | - | <input type="checkbox"/> |
| | | Door | | Set Screws in Collar | | Grounding Lug | | Coating |
| | | NL=No Logo Blank=Pelco Logo | | 1S=1 Hex Bolt 3S=3 Set Screws Blank=None | | GL=Ground Lug Blank=None | | PNC=Process No Color P__=Paint |

Square Base Assembly, Alum Steel Coupling w/ Plastic Door

| | | | | | | | | |
|---------|---|--------------------------------|---|--|---|-----------------------------|---|-----|
| PB-5341 | - | <input type="checkbox"/> | - | <input type="checkbox"/> | - | <input type="checkbox"/> | - | PNC |
| | | Door | | Set Screws in Collar | | Grounding Lug | | |
| | | NL=No Logo Blank=Pelco Logo | | 1S=1 Hex Bolt 3S=3 Set Screws Blank=None | | GL=Ground Lug Blank=None | | |

Square Base Assembly, Alum Slip Fit w/ Alum Door

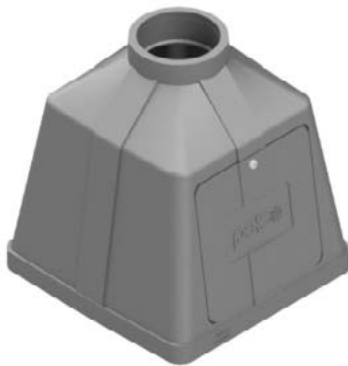

| | | | | | | |
|---------|---|--------------------------------|---|-----------------------------|---|-----------------------------------|
| PB-5338 | - | <input type="checkbox"/> | - | <input type="checkbox"/> | - | <input type="checkbox"/> |
| | | Door | | Grounding Lug | | Coating |
| | | NL=No Logo Blank=Pelco Logo | | GL=Ground Lug Blank=None | | PNC=Process No Color P__=Paint |

Square Base Assembly, Alum Slip Fit w/ Plastic Door

| | | | | | | |
|---------|---|--------------------------------|---|-----------------------------|---|-----|
| PB-5339 | - | <input type="checkbox"/> | - | <input type="checkbox"/> | - | PNC |
| | | Door | | Grounding Lug | | |
| | | NL=No Logo Blank=Pelco Logo | | GL=Ground Lug Blank=None | | |

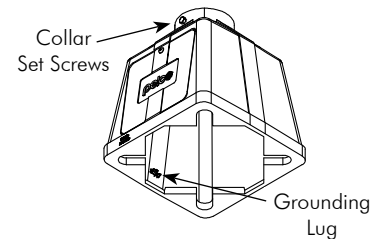
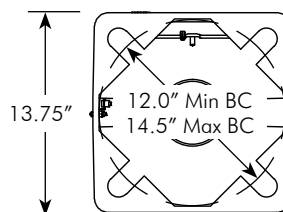
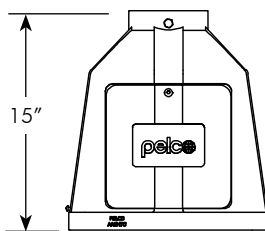

Note: 1. All assemblies are supplied standard with stainless fasteners.
2. See Reference Section for available paint colors.



Square Pedestal Bases

Iron

Pelco offers aluminum, iron, and plastic bases in various sizes as well as poles in aluminum and steel. Pelco's PB-5334 and PB-5335 cast aluminum square bases are FHWA certified and meets or exceeds AASHTO break-away requirements. Plastic replacement doors offer an economical way to deter vandalism.



Square Base Assembly, Iron w/ Iron Door

| | | | | | | |
|---------|---|--|---|-----------------------------------|---|-----------------------------|
| PB-5308 | - | <input type="checkbox"/> | - | <input type="checkbox"/> | - | <input type="checkbox"/> |
| | | Set Screws in Collar | | Grounding Lug | | Coating |
| | | 1S=1 Hex Bolt 3S=3 Set Screws Blank=None | | GL=Grounding Lug Blank=None | | GLV=Galvanized P__=Paint |

Square Base Assembly, Iron w/ Iron Door



| | | | | | | |
|---------|---|--|---|-----------------------------------|---|-----------------------------|
| PB-5511 | - | <input type="checkbox"/> | - | <input type="checkbox"/> | - | <input type="checkbox"/> |
| | | Set Screws in Collar | | Grounding Lug | | Coating |
| | | 1S=1 Hex Bolt 3S=3 Set Screws Blank=None | | GL=Grounding Lug Blank=None | | GLV=Galvanized P__=Paint |

Note:
"Buy American" Certification available upon request at time of order.

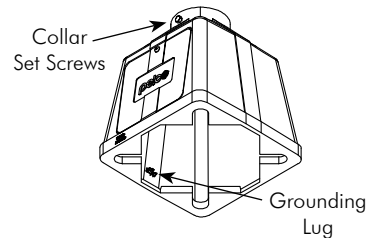
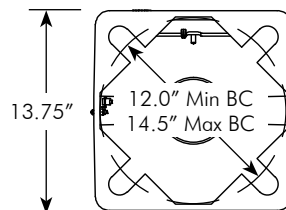
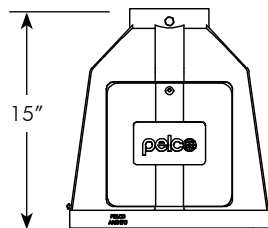

Note: 1. All assemblies are supplied standard with stainless fasteners.
2. See Reference Section for available paint colors.



Octagonal Pedestal Bases Aluminum

Pelco offers aluminum, iron, and plastic bases in various sizes as well as poles in aluminum and steel. Pelco's PB-5334 and PB-5335 cast aluminum square bases are FHWA certified and meets or exceeds AASHTO break-away requirements. Plastic replacement doors offer an economical way to deter vandalism.



Octagonal Base Assembly, Alum w/ Alum Door

| | | | |
|---------|--|-----------------------------------|-----------------------------------|
| | Set Screws in Collar | Grounding Lug | Coating |
| PB-5349 | - <input type="checkbox"/> | - <input type="checkbox"/> | - <input type="checkbox"/> |
| | 1S=1 Hex Bolt 4S=4 Set Screws Blank=None | GL=Grounding Lug Blank=None | PNC=Process No Color P__=Paint |



Octagonal Base Assembly, Alum Slip Fit w/ Alum Door

| | | |
|---------|-----------------------------------|-----------------------------------|
| | Grounding Lug | Coating |
| PB-5350 | - <input type="checkbox"/> | - <input type="checkbox"/> |
| | GL=Grounding Lug Blank=None | PNC=Process No Color P__=Paint |

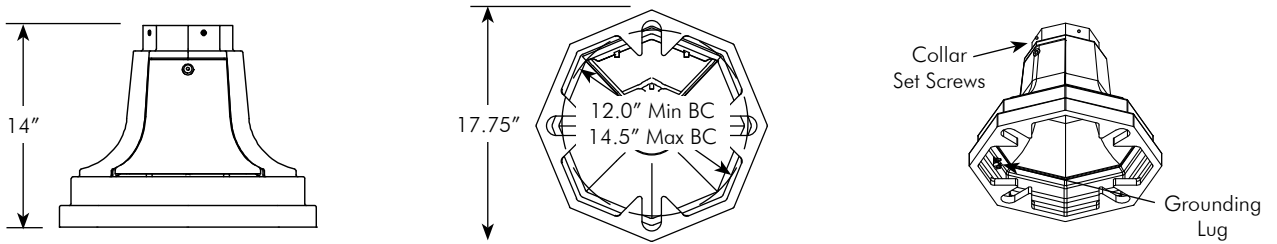

Note: 1. All assemblies are supplied standard with stainless fasteners.
2. See Reference Section for available paint colors.



Octagonal Pedestal Bases Iron

Pelco offers aluminum, iron, and plastic bases in various sizes as well as poles in aluminum and steel. Pelco's PB-5334 and PB-5335 cast aluminum square bases are FHWA certified and meets or exceeds AASHTO break-away requirements. Plastic replacement doors offer an economical way to deter vandalism.



Octagonal Base Assembly, Iron w/ Iron Door

| | | | |
|---------|--|-----------------------------------|-----------------------------|
| | Set Screws in Collar | Grounding Lug | Coating |
| PB-5310 | - <input type="checkbox"/> | - <input type="checkbox"/> | - <input type="checkbox"/> |
| | 1S=1 Hex Bolt 4S=4 Set Screws Blank=None | GL=Grounding Lug Blank=None | GLV=Galvanized P__=Paint |

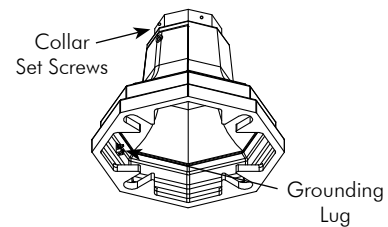
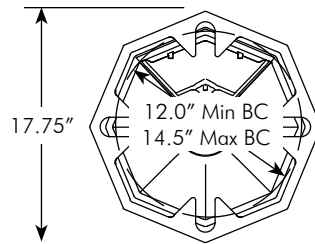
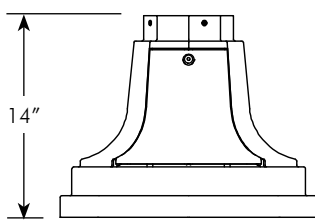

Note: 1. All assemblies are supplied standard with stainless fasteners.
2. See Reference Section for available paint colors.



Pedestal Bases

Pelco offers aluminum, iron, and plastic bases in various sizes as well as poles in aluminum and steel. Pelco's PB-5334 and PB-5335 cast aluminum square bases are FHWA certified and meets or exceeds AASHTO break-away requirements. Plastic replacement doors offer an economical way to deter vandalism.



2-Piece Base for 4-1/2" OD Pole, Plastic

PB-5303-PNC

Note:
High Density Crosslinkable Polyethylene Pedestal Pole Base.
Complete with all hardware. No anchor bolts required.



2-Piece Reducer, Alum

PB-5328-PNC

Note:
2-Piece Aluminum Reducer for PB-5303-PNC Base. (Reduces 4-1/2" OD to 3-1/2" OD)

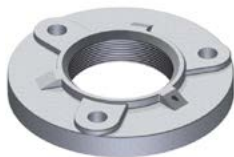

Flange Base, 4"-8NPT, Galv Iron

PB-5304-GLV

Note:
Three 13/16" mounting holes on 7-1/4" bolt circle.

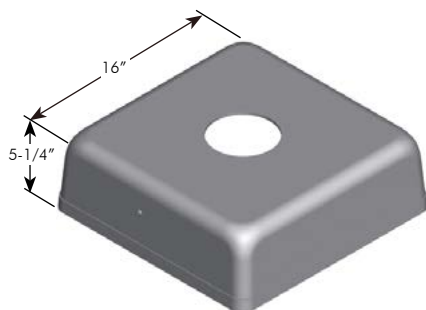
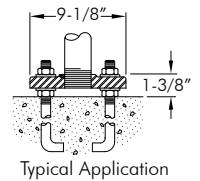

2-Piece Square Cover, Alum

| | | | |
|---------|----------------------|---|----------------------|
| | Pole Diameter | - | Coating |
| PB-5399 | <input type="text"/> | - | <input type="text"/> |
| | 4.5=4.5" OD | | PNC=Process No Color |
| | 8=8" OD | | P__=Paint |

Note:
For 4-1/2" - 8" OD Pole (15" Max. Bottom Opening). Complete with all hardware.

Note: 1. All assemblies are supplied standard with stainless fasteners.
2. See Reference Section for available paint colors.



Pole & Arm Caps

Pelco offers pole and arm caps in various sizes in both aluminum and steel. Caps for 4-1/2" OD posts are available in aluminum and ABS plastic.



Pole Cap, Acorn Type, Alum, 3" OD Pole

PB-5403 - Coating
PNC=Process No Color
P__=Paint



Pole Cap, Acorn Type, Alum, 3-1/2" OD Pole

PB-5407 - Coating
PNC=Process No Color
P__=Paint

Pole Cap, Acorn Type, Alum, 4-1/2" OD Pole

PB-5401 - Coating
PNC=Process No Color
P__=Paint



Pole Cap, Dome Type, Alum, 4-1/2" OD Pole

PB-5402 - Coating
PNC=Process No Color
P__=Paint

Note: 1. All assemblies are supplied standard with stainless fasteners.
2. See Reference Section for available paint colors.



Pole & Arm Caps

Pelco offers pole and arm caps in various sizes in both aluminum and steel. Caps for 4-1/2" OD posts are available in aluminum and ABS plastic.



Pole & Arm Cap, Alum

AP-0101 - **2-5/16" to 3-1/2" OD Pole**
 Coating
 PNC=Process No Color
 P__=Paint

AP-0102 - **3" to 4" OD Pole**
 Coating
 PNC=Process No Color
 P__=Paint

AP-0103 - **4-3/16" to 5-3/16" OD Pole**
 Coating
 PNC=Process No Color
 P__=Paint

AP-0104 - **5-3/16" to 6-3/16" OD Pole**
 Coating
 PNC=Process No Color
 P__=Paint

AP-0105 - **6-1/8" to 7-1/8" OD Pole**
 Coating
 PNC=Process No Color
 P__=Paint

AP-0106 - **7-3/16" to 8-1/4" OD Pole**
 Coating
 PNC=Process No Color
 P__=Paint

AP-0107 - **8-3/16" to 9-3/16" OD Pole**
 Coating
 PNC=Process No Color
 P__=Paint

AP-0108 - **9-7/16" to 10-7/16" OD Pole**
 Coating
 PNC=Process No Color
 P__=Paint

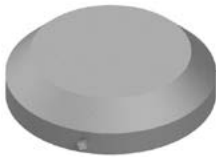

Note: 1. All assemblies are supplied standard with stainless fasteners.
 2. See Reference Section for available paint colors.



Pole & Arm Caps

Pelco offers pole and arm caps in various sizes in both aluminum and steel. Caps for 4-1/2" OD posts are available in aluminum and ABS plastic.



AP-0109 - **Pole & Arm Cap, Alum**
10-11/16" to 11-11/16" OD Pole

Coating

PNC=Process No Color
P__=Paint

AP-0110 - **Pole & Arm Cap, Alum**
11-7/8" to 12-11/16" OD Pole

Coating

PNC=Process No Color
P__=Paint



AP-0450 - - **Pole Cap, Steel**

Pole Diameter Coating

- P__=Paint
- 13.25=12.57"-13.38" OD
 - 14.25=13.39"-14.38" OD
 - 15.25=14.39"-15.38" OD
 - 16.25=15.39"-16.38" OD
 - 17.25=16.39"-17.38" OD
 - 18.25=17.39"-18.38" OD
 - 19.25=18.39"-19.38" OD
 - 20.25=19.39"-20.38" OD
 - 21.25=20.39"-21.38" OD
 - 22.25=21.39"-22.38" OD
 - 23.25=22.39"-23.38" OD
 - 24.25=23.39"-24.38" OD



SH-1608 - **Post Top Cap, 4" (4-1/2" OD Pole)**
for Extruded Sign Blade, Alum

Coating

PNC=Process No Color
P__=Paint

SH-1615 - **Post Top Cap, 4" (4-1/2" OD Pole)**
for Flat Sign Blade, Alum

Coating

PNC=Process No Color
P__=Paint



AP-0805-PNC **Pole Cap, ABS Plastic**
for up to 4" OD Pole

AP-0806-PNC **Pole Cap, ABS Plastic**
for up to 5" OD Pole

Note: 1. All assemblies are supplied standard with stainless fasteners.
2. Specify options when ordering.
3. See Reference Section for available paint colors.



Collars & Adapters

Pole and base collar assemblies, for both square and octagonal bases, are available in highwind areas to add strength and help prevent loosening of connection.



Pole & Base Collar Assembly, Alum Square Base

PB-5325 - Coating
 PNC=Process No Color
 P__=Paint

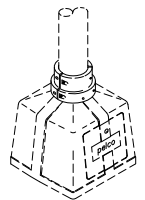

Pole & Base Collar Assembly, Alum Octagonal Base

PB-5326 - Coating
 PNC=Process No Color
 P__=Paint

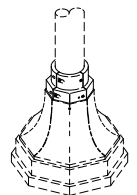

Pedestal Adapter, 4" (4-1/2" OD Pole), Alum 6-1/2" Bolt Circle

SE-3104 - Coating
 PNC=Process No Color
 P__=Paint

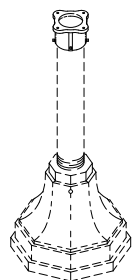

Note: 1. All assemblies are supplied standard with stainless steel fasteners.
 2. Specify options when ordering.
 3. See Reference Section for available paint colors.



Anchor Bolt Sets

Pelco's galvanized anchor bolt sets are available in a variety of sizes.

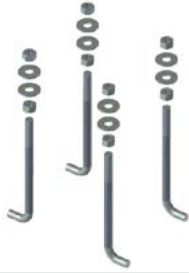

Anchor Bolt Set of 4 w/ Hardware 1/2"-13NC x 7-1/2", Galv

AP-1046-GLV

Note: Includes 4 Bolts, 8 Washers, and 8 Nuts.

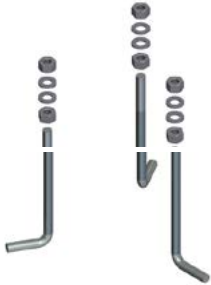

Anchor Bolt Set of 3 w/Hardware 3/4"-10NC x 18", Galv

PB-5305-GLV

Note: Includes 3 Bolts, 6 Washers and 6 Nuts.



Anchor Bolt Set of 4 w/ Hardware 3/4"-10NC x 18", Galv

PB-5306-GLV

Note: Includes 4 each: Bolts, Washers and Nuts.

PB-5518-GLV

Note: Includes 4 Bolts, 8 Washers and 8 Nuts.



Anchor Bolt Set of 4 w/ Plate Washers 3/4"-10NC x 18", Galv

PB-5371-GLV

Includes 4 Bolts, 4 Plate Washers, 4 Washers, and 4 Nuts.



Anchor Bolt Set of 4 w/ Hardware 1"-8NC x 36", Galv

AP-1007-  -GLV

Template

- 1=12" Bolt Circle
- 2=12.75" Bolt Circle
- 3=11" Bolt Circle

Includes 4 Bolts, 4 Lock Washers, 8 Washers, and 8 Nuts.

Note: 1. All assemblies are supplied standard with galvanized fasteners.



Anchor Bolt Cages

Anchor bolt cages allow the critical bolt circle dimensions to be maintained when the steel is cast into the concrete. These cages may be used instead of anchor bolt sets.



Anchor Bolt Cage, Galv
1/2"-13NC x 7-1/2" w/ 36" Rebar
5-1/2" Bolt Circle

AP-1049-GLV

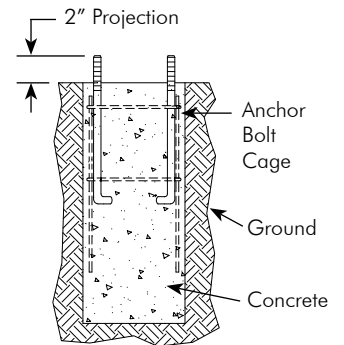

Typical Footing Detail



Anchor Bolt Cage, Galv
3/4"-10NC x 18" w/ 36" Rebar
8-1/2" Bolt Circle

AP-1089-GLV

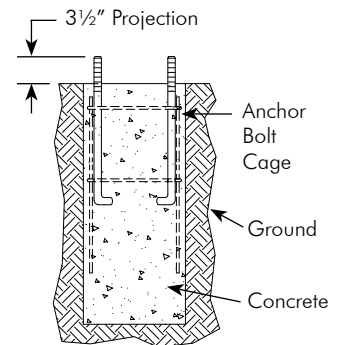

Typical Footing Detail



Anchor Bolt Cage, Galv
3/4"-10NC x 18" w/ 36" Rebar
13" Bolt Circle

AP-1095-GLV

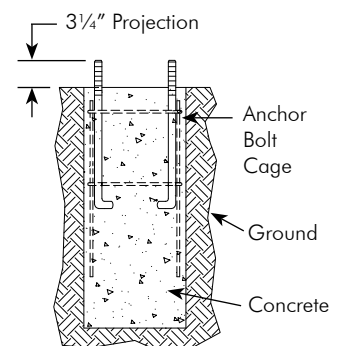

Typical Footing Detail

Note: 1. All assemblies are supplied standard with galvanized fasteners.
 2. Footing shall be determined by end user.

Anchor Bolt Cages

Anchor bolt cages allow the critical bolt circle dimensions to be maintained when the steel is cast into the concrete. These cages may be used instead of anchor bolt sets.



Anchor Bolt Cage, Galv
1"-8NC x 36"
15" Bolt Circle

AP-3136-GLV

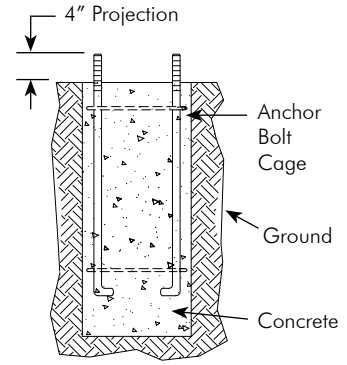

Typical Footing Detail



Anchor Bolt Cage, Galv
1"-8NC x 36"
11" Bolt Circle,

AP-3129-GLV

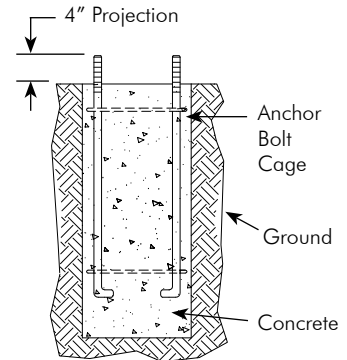

Typical Footing Detail

Note: 1. All assemblies are supplied standard with galvanized fasteners.
2. Footing shall be determined by end user.



Pole & Base Accessories

Pelco offers various accessories for pedestal bases from grounding lugs to plastic hand hole covers.

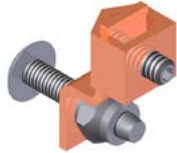

PB-5323-PNC **Grounding Lug
w/ Mounting Hardware**

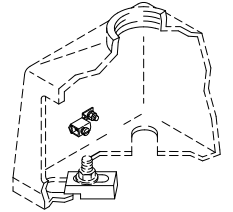

PB-0532-PNC **Anchor Bolt Adapter,
Alum**

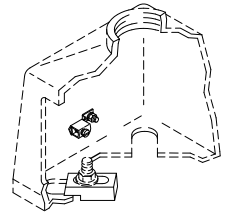

PB-0602-GLV **Shim, 1/16" x 2" x 2", Steel, Galv**

PB-0603-GLV **Shim, 1/8" x 2" x 2", Steel, Galv**

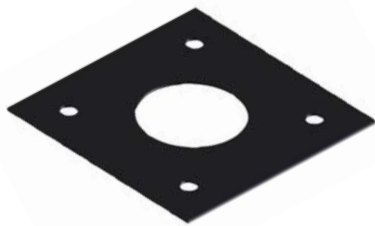

PB-0550-PNC **Template, ABS Plastic
13" Bolt Circle
for Square and Octagonal Bases**



PB-5356-PNC **Universal Hand Hole Cover, ABS Plastic
fits 2-3/4" x 4-1/2" to 5" x 8"**

Note: 1. All assemblies are supplied standard with stainless steel fasteners.
2. Specify options when ordering.



Plastic Replacement Doors

Plastic replacement doors for lighting pole bases are fabricated from tough hi-density UV inhibited plastic which offers excellent impact resistance. They give the appearance of aluminum, never needing painted and are a significant deterrent to vandalism since they have no scrap value. Pelco's doors withstand temperature extremes of -78° to +150° fahrenheit.

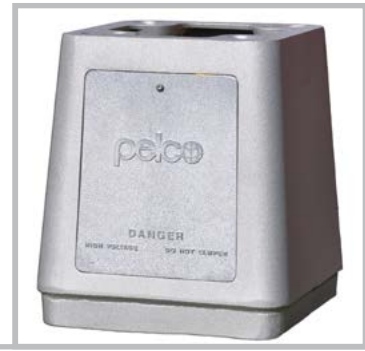

Transformer Door, Plastic

Base
Manufacturer
PB-0522 -  - PNC
*See Chart

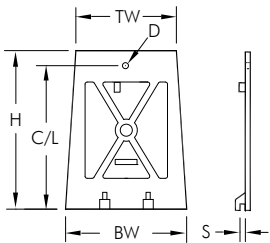
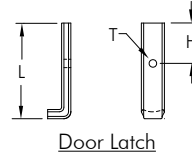

| *BASE MFG | DESCRIPTION | S | C/L | H | DOOR SIZE | | HOLE D | LATCH | | |
|-----------|-------------------|-------|----------|-----------|-----------|--------|--------|-------|-----|-----|
| | | | | | TW | BW | | L | H | T |
| 03 | Valmont, Flat | 5/16" | 12-5/8" | 13-3/4" | 7-15/16" | 9-1/4" | 3/8" | N/A | N/A | N/A |
| 04 | Union Metal, Flat | 5/16" | 13-5/16" | 13-15/16" | 7-59/64" | 9-1/4" | 3/8" | N/A | N/A | N/A |

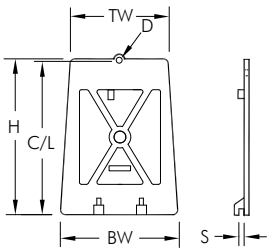

| *BASE MFG | DESCRIPTION | S | C/L | H | DOOR SIZE | | HOLE D | LATCH | | |
|-----------|--|-------|-----------|----------|-----------|----------|--------|-------|-----|-----|
| | | | | | TW | BW | | L | H | T |
| 05-06 | Valmont-Akron, Flat (TB-1AF, TB-2AF, TB-3AF) | 1/4" | 13-1/2" | 13-1/4" | 9-1/8" | 9-1/2" | 3/8" | N/A | N/A | N/A |
| 07 | A.B. Chance, Flat | 3/8" | 13-5/16" | 13-7/8" | 9-1/16" | 9-13/16" | 3/8" | N/A | N/A | N/A |
| 12 | Hapco, Flat (56631, 56632) | 5/16" | 13-5/8" | 13-7/16" | 9-1/8" | 9-5/8" | 3/8" | N/A | N/A | N/A |
| 19 | P & K, C-98612, Flat (M-81) | 3/8" | 16-21/32" | 16-1/2" | 10-1/2" | 13-1/2" | 11/32" | N/A | N/A | N/A |

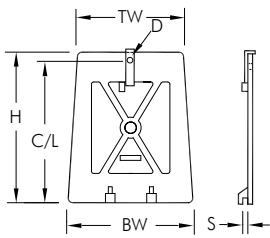

| *BASE MFG | DESCRIPTION | S | C/L | H | DOOR SIZE | | HOLE D | LATCH | | |
|-----------|---|-------|---------|-----------|-----------|----------|--------|--------|--------|----------|
| | | | | | TW | BW | | L | H | T |
| 01 | Kaiser, Curved w/ Latch | 3/8" | 13-3/4" | 14-7/8" | 10-5/8" | 11-3/4" | 11/32" | 4-5/8" | 1-3/4" | 5/16"-18 |
| 08 | P & K, Flat w/ Latch (TB2A, TB2C, TB5C) | 1/4" | 11-7/8" | 13-1/4" | 8-1/4" | 9-15/16" | 11/32" | 3-1/4" | 1-3/4" | 5/16"-18 |
| 15 | Akron, Flat w/ Latch (TB-20S) | 1/4" | 12" | 13-3/8" | 9-1/8" | 9-5/8" | 5/16" | 3-3/8" | 1-7/8" | 1/4"- 20 |
| 16 | Akron, Flat Short w/ Latch (TB-17S) | 5/16" | 11-1/8" | 11-23/32" | 9-1/8" | 9-5/8" | 5/16" | 2-3/8" | 1-1/8" | 1/4"- 20 |
| 22 | Akron, Curved w/ Latch (FP-5190) | 3/8" | 12" | 13-5/16" | 8-1/2" | 9-1/2" | 11/32" | 3-1/4" | 1-3/4" | 5/16"-18 |

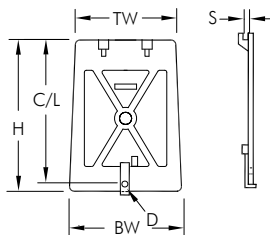

| *BASE MFG | DESCRIPTION | S | C/L | H | DOOR SIZE | | HOLE D | LATCH | | |
|-----------|--|-------|-----|---------|-----------|--------|--------|--------|--------|----------|
| | | | | | W | BW | | L | H | T |
| 10 | P & K, Flat w/ Latch (REVERSED OPENING TB-1, TB-2) | 9/16" | 12" | 13-3/8" | 8-3/8" | 9-5/8" | 11/32" | 3-1/4" | 1-3/4" | 5/16"-18 |

- Note: 1. All assemblies are supplied standard with stainless fasteners.
2. Doors w/latches include latch & vandal-resistant screw. Doors without latches are shipped without hardware.
3. Specify options when ordering.



Plastic Replacement Doors

Plastic replacement doors for lighting pole bases are fabricated from tough hi-density UV inhibited plastic which offers excellent impact resistance. They give the appearance of aluminum, never needing painted and are a significant deterrent to vandalism since they have no scrap value. Pelco's doors withstand temperature extremes of -78° to +150° fahrenheit.

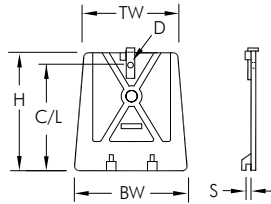

| *BASE MFG | DESCRIPTION | S | C/L | H | DOOR SIZE | | HOLE D | LATCH | | |
|-----------|-----------------------------------|-------|----------|---------|-----------|---------|--------|--------|--------|----------|
| | | | | | W | BW | | L | H | T |
| 11 | P & K, Flat Short w/ Latch (TB-4) | 5/16" | 9-13/16" | 11-1/8" | 9-9/16" | 11-5/8" | 11/32" | 3-1/4" | 1-3/4" | 5/16"-18 |

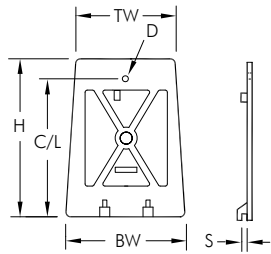

| *BASE MFG | DESCRIPTION | S | C/L | H | DOOR SIZE | | HOLE D | LATCH | | |
|-----------|---------------|-------|-----------|---------|-----------|--------|--------|-------|-----|-----|
| | | | | | TW | BW | | L | H | T |
| 13 | Valmont, Flat | 5/16" | 12-15/16" | 13-7/8" | 7-15/16" | 9-1/4" | 3/8" | N/A | N/A | N/A |
| 25 | FAB, Flat | 5/16" | 12-7/8" | 13-5/8" | 8-1/2" | 9-3/4" | 5/16" | N/A | N/A | N/A |

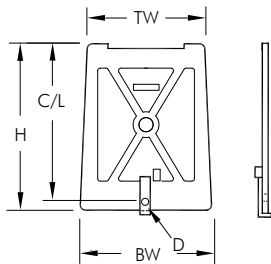

| *BASE MFG | DESCRIPTION | S | C/L | H | DOOR SIZE | | HOLE D | LATCH | | |
|-----------|---|-----|----------|---------|-----------|----------|--------|--------|--------|----------|
| | | | | | W | BW | | L | H | T |
| 18 | Akron, Flat, Hinged w/ Latch (REVERSE OPENING TB-17H) | N/A | 10-3/16" | 11-5/8" | 9-1/8" | 9-11/16" | 5/16" | 3-3/8" | 1-7/8" | 1/4"- 20 |

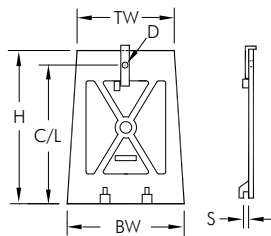

| *BASE MFG | DESCRIPTION | S | C/L | H | DOOR SIZE | | HOLE D | LATCH | | |
|-----------|----------------------------|-------|---------|---------|-----------|--------|--------|--------|--------|---------|
| | | | | | W | BW | | L | H | T |
| 24 | Union Metal, Flat w/ Latch | 5/16" | 3-5/16" | 13-3/4" | 7-59/64" | 9-1/4" | 13/32" | 3-3/8" | 11/16" | 3/8"-16 |

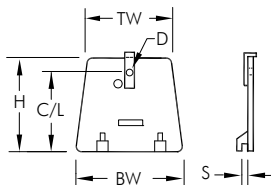

| *BASE MFG | DESCRIPTION | S | C/L | H | DOOR SIZE | | HOLE D | LATCH | | |
|-----------|---------------------------------------|-------|--------|--------|-----------|----|--------|--------|--------|----------|
| | | | | | W | BW | | L | H | T |
| 14 | P & K, Curved, Small w/ Latch (HBS-6) | 7/32" | 4-1/2" | 5-1/4" | 5-3/16" | 6" | 9/32" | 2-3/8" | 1-1/8" | 1/4"- 20 |

- Note: 1. All assemblies are supplied standard with stainless fasteners.
 2. Doors w/latches include latch & vandal-resistant screw. Doors without latches are shipped without hardware.
 3. Specify options when ordering.



Transformer Bases

Pelco's Transformer bases stand 17" tall and comes complete with an aluminum Pelco door and 8 heavy duty galvanized steel washers. A transformer base hardware kit is optional.



Transformer Base , TB2-17, Alum w/ Pelco Door & Galvanized Washers



PB-5514 - -
 Hardware Kit Coating
 Blank=None PNC=Process No Color
 HK=Hardware Kit P__=Paint

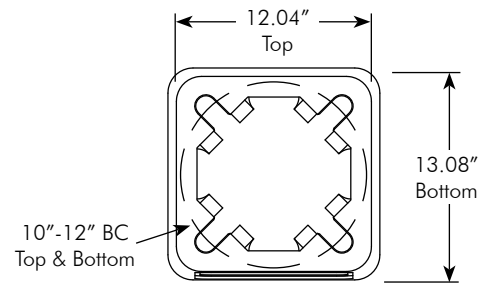

Transformer Base , TB1-17, Alum w/ Pelco Door & Galvanized Washers



PB-5517 - -
 Hardware Kit Coating
 Blank=None PNC=Process No Color
 HK=Hardware Kit P__=Paint

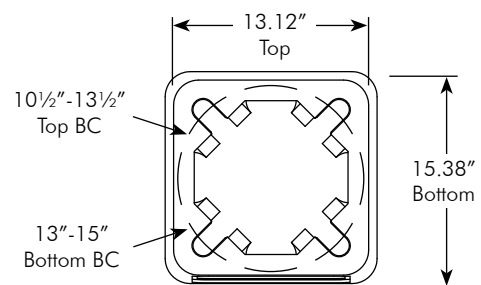

Note: 1. Hardware kits are galvanized steel.
 2. See Reference Section for available paint colors.



Transformer Bases

Pelco's Transformer bases stand 17" tall and comes complete with an aluminum Pelco door and 8 heavy duty galvanized steel washers. A transformer base hardware kit is optional.

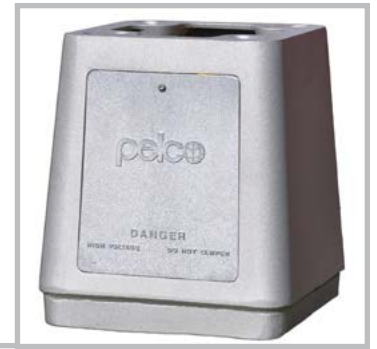

Transformer Base , TB1-17 Modified, Alum w/ Pelco Door & Galvanized Washers



PB-5538 - -
 Hardware Kit Coating
 Blank=None PNC=Process No Color
 HK=Hardware Kit P__=Paint

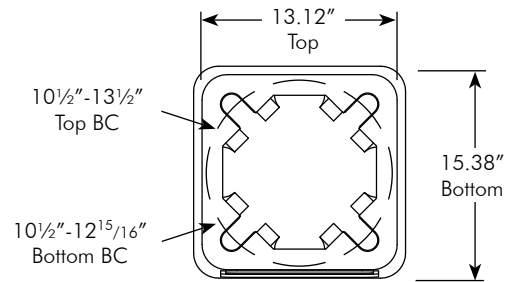

Hardware Kit , Transformer Base 1"-8NC x 4", Set of 4, Galvanized



PB-5437-GLV

Note:
 For mounting base plates to the top of Transformer Bases.
 Includes 4 Hex Head Bolts, 8 Washers, 4 Lock Washers, and 4 Hex Nuts.

Note: 1. Hardware kits are galvanized steel.
 2. See Reference Section for available paint colors.

